

- WARRANTY -

1. We hereby guarantee the product as follow in accordance with the regulation of consumer damage compensation.
2. In case of failure of the product, please inform the distributor where you purchased the product.
3. Product Warranty will be effective for one year from date of purchase.

Product Name			Warranty Period
Model Name			One (1) year since the date purchased
Date Purchased			
SER.No.			
Customer's Address	Name		
	Tel.No		
Distributor's Address	Name		
	Tel.No.		

Regarding Product Warranty Regulation...

1. We will repair the product at free of charge in case it was failed under the normal operating condition in accordance with the user guide during the warranty period.
2. Although it is within the warranty period, we will charge the repair service fee etc. (repair + product + travel expense) if it falls under the following cases.

Voiding warranty

1. Defects occurred from the user's careless handling
2. Defects occurred from the usage with incorrect power voltage (E.g., 220V was used to the 110V product.)
3. Defects occurred from the improper repair done by the person other than our service engineer.
4. Defects occurred from Force Majeure (fire, salt, flood, etc.)
5. Failure or damage due to the drop, etc. (user's mis-handling) during the operation after installed
6. Defect occurred from the interior modification at user's discretion
7. In case the life cycle of the part expired

Mail, email or fax the warranty form to:

YOUR LOCAL DEALER FIRST where you bought this appliance

If your dealer is unable to assist you



94, Robot land-ro 249beon-gil, Seo-gu, Incheon, Korea
www.lstdaewon.co.kr

dib

LIFE STYLE DESIGNER

User's Guide

This user's guide contains the product warranty certificate.

Be sure to read this user's guide carefully before use.

220V ~ 240V, 50/60Hz

www.lstdaewon.co.kr

DIB-J500 Series

DIB-J540/J520/J500

dib...

**THIS UNIT WAS MANUFACTURED FOR HOUSEHOLD USE ONLY.
READ ALL OPERATING INSTRUCTIONS BEFORE INSTALLATION.**

Notes

- 1. This product should be installed according to this manual.
- 2. Please read this manual carefully and install properly.
- 3. Please save this manual and place it at an easily accessible place.
- 4. Do not attempt to service this appliance yourself. Doing so could void warranty.

CONTENTS

1. Safety Instructions	4
2. Product Characteristics	8
3. Designation of Each Component	9
4. Installation	11
5. Trial Operation	13
6. How to Use the Product	14
7. User Settings	18
8. Maintenance & Cleaning	20
9. Before requesting repair	21
10. Product Specifications	22
11. Comparison Chart	23
12. Warranty	24

Preparation

Installation

Operation

Maintenance & Cleaning

01. Safety Instructions

● Each symbol refers to the followings:

 **Warning** Risk of hazardous or lethal damage when violating the instructions.

 **Caution** Risk of injury or material damage when violating the instructions.

● Each pictorial indication means the followings:

 means prohibition

-  Disassembly is not allowed
-  Don't touch with wet hand
-  Use of fire prohibited
-  Don't spray water
-  General prohibition

 means obligation

-  Obligatory Instruction
-  Grounding Connection

Warning

Disassembly, modification or repair is not allowed.

▶ Risk of electric shock or fire.

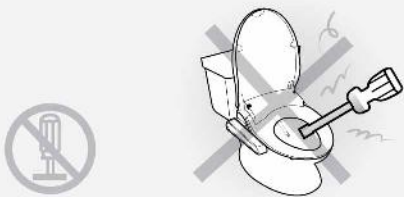

Don't plug or touch the power cord with wet hands.

▶ Risk of electric shock.

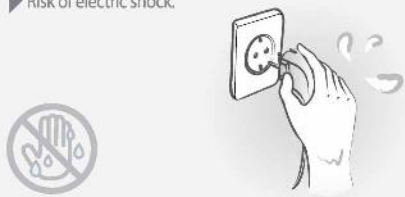

Don't spray water on the main body of product or power plug.

▶ Risk of electric shock or fire

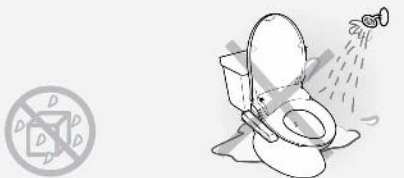

Don't use the damaged power cord or outlet.

▶ Risk of electric shock or fire



Warning

Don't fail to do grounding.

- ▶ Always use the outlet that encloses the earth electrode (Earth terminal mounting outlet-check if there is earth or not).
- ▶ In case there is no earth electrode, do grounding separately.
- ▶ When it is not grounded, it causes the failure and electric shock.

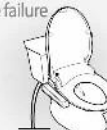

Insert the power plug correctly in 220~240V exclusive outlet.

▶ Risk of heat or fire.



Don't locate the cigarette or flammable materials near the product ; Don't throw the cigarette into the product.



Don't connect the product to the water pipe of industrial use.

▶ Risk of causing dermatitis of user.

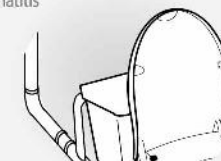

Don't connect power to the product before its complete installation on the toilet.



When the power cord or plug is damaged, always inform the service center, and replace if required.



Don't block the hot air hole nor put any object or hand on the hole.

▶ Risk of burn or electric shock. (DIB-J520, J540 only)



When removing the product from toilet, always release the power plug first.

▶ Risk of electric shock.



01. Safety Instruction

⚠ Caution

Don't stand on the product ; don't put heavy object on it.

▶ Risk of injury or damage to the product.

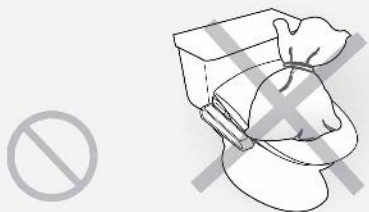

Don't force to close the cover of toilet.

▶ Risk of failure.

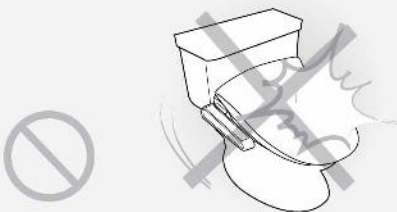

Don't force to lean against the cover of toilet.

▶ Risk of failure.



When cleaning, don't use toilet-use detergent, benzene, thinner, etc.

▶ Risk of damage to the product or crack.

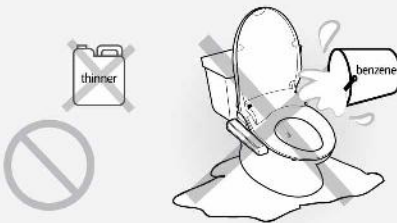

Don't bend the connecting hose ; don't force to pull it out.

▶ It may cause stoppage of water supply or leakage.

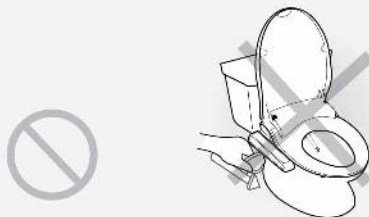

Be cautious low temperature burn.

▶ When the skin has been in contact with a seat for a long time, it may cause low temperature burn. The seat temperature should be set on Low or off when the unit is used for children, elderly persons, persons who cannot control the temperature by themselves.



⚠ Caution

When the product is not used an extended period of time, remove the power plug and drain the water out of the product tank.

▶ It may cause the water rotten and result the skin disease.

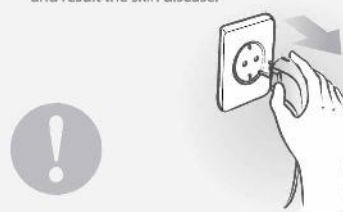

Don't use with the product out of order.

▶ When it is out of order, remove the plug from the outlet and inform the service center.
▶ Otherwise, it may cause fire or electric shock.



When installing, push it in until it sounds 'Click'.

▶ It may cause water leakage or mal-operation.



Don't place the removed product upside down.

▶ Risk of the product failure.

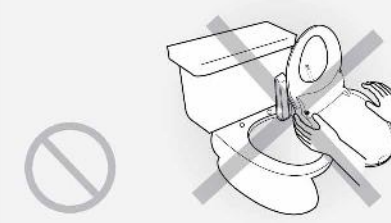

Do not use a hair spray or air fresher near by the bidet seat.

▶ It may cause black dots or discoloration.

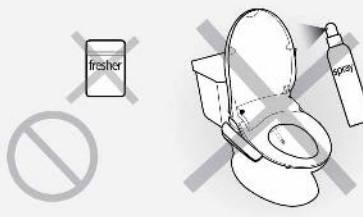

02. Product Characteristics

dīb bidet has the following characteristics:

● Advanced hybrid heating technology

Enjoy continuous warm water throughout the wash cycle.

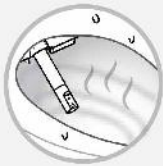

● Power wash

Soft but powerful water wash for added cleansing benefit.



● Bubble Wash

Aerated water wash adds cleaning comfort.

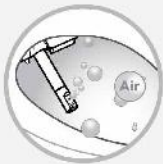

● Stainless steel nozzle

For better hygiene, a stainless steel nozzle is applied.



● Pulse

Pulsating wash repeatedly cycles from weak to strong.



● Massage

Nozzle moves back and forth for massage effect.

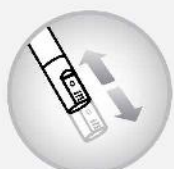

● Energy Saving Function

Two modes in energy saving function maximize energy saving effect.



● Child Settings

Specialized nozzle position and water pressure for children.



03. Designation of Each Component

Main Body

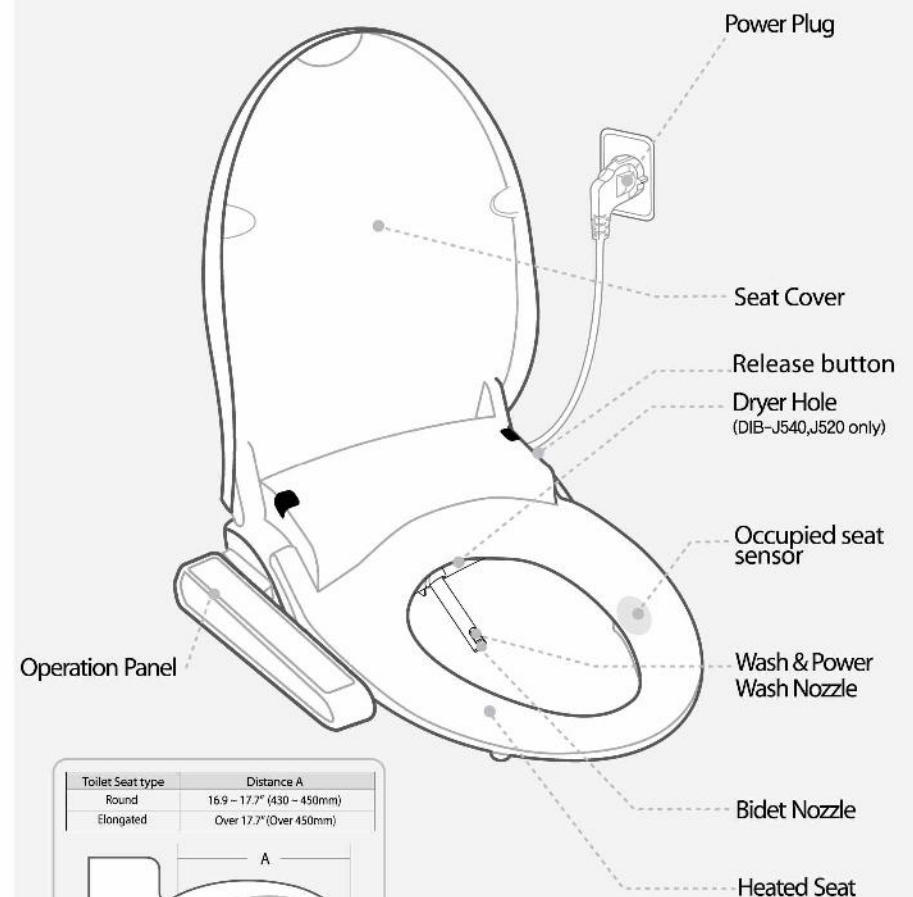

Toilet Seat type	Distance A
Round	16.9 - 17.7" (430 - 450mm)
Elongated	Over 17.7" (Over 450mm)

* Occupied seat sensor

- The occupied seat sensor must be activated to operate the unit.
- The unit will work without activation of occupied seat sensor if this function is released intentionally.
- Refer to page No. 18.

03. Designation of Each Component

Operation Panel

STOP
To stop any functions
To power off, press this for 3 seconds.

WASH
To run for posterior wash or sitz bath function.

BIDET
To run for feminine wash or sitz bath function.

◀ / ▶
Controls the nozzle position as desired. Press this for 3 seconds, nozzle comes out for manual cleaning.

PULSE
To run the PULSE function on the model of WASH/BIDET/POWER WASH. The water pressure is rhythmically changed from strong to weak. Press this for 3 seconds to release the seat sensor.

CHILD
Children safety mode. All settings are adjusted for child and after wash dry works automatically.

ENERGY SAVING
1 step: automatic mode
2 step: powerful saving
3. cancellation

POWER WASH
To run the power wash function.

DRY
To run the dry function. Temperature is djustable by +/- button. (DIB-C520/C540 only)

+ / -
Adjusting water pressure/dry level in 5 steps

MASSAGE
To run the MASSAGE function, nozzle is moving forward and backward repeatedly.

SEAT TEMP
To adjust the seat temp. by 4 steps. OFF-LOW-MID-HI

WATER TEMP
To adjust the water temp. by 4 steps. OFF-LOW-MID-HI

Accessories

Bolts

Nuts

Washers

Cone packings

Bracket Holders

Bracket

Spare nut

Rubber washer (for Spare nut)

※ Optional

Filter

※ Optional

T-Valve

Water Feed Hose (for Toilet)

Water Feed Hose (for Bidet)

04. Installation

Order of Installation

1 Remove the seat from the existing toilet body.

- ▶ Release the nuts, and then remove the seat and cover from it.
- ▶ Keep the removed seat, cover and nuts well in a proper place.



2 Close the water feed valve by turning it clockwise, and then drain the toilet water tank out.

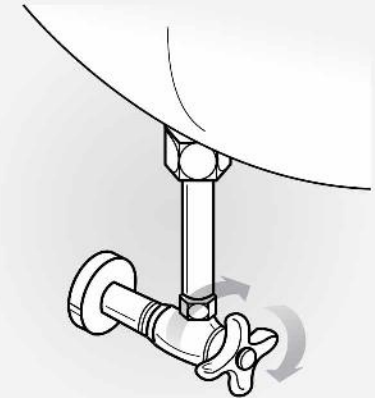

3 Remove the water feed pipe and then install T-valve.

- ▶ Keep the removed water feed pipe well in a proper place. It may be useful when moving house to other place later.



4 Connect the toilet-use hose.



04. Installation

5 Fix the bracket onto the toilet first.

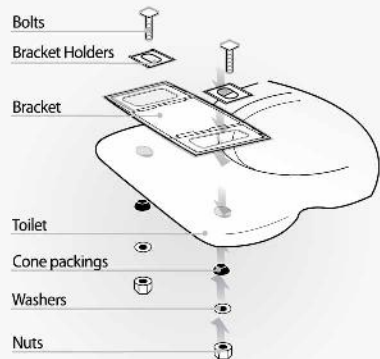

▶ Adjust the seat and the front part of toilet back and forth so that they can correspond with before fastening the nuts.

6 Push the main body toward the bracket completely.

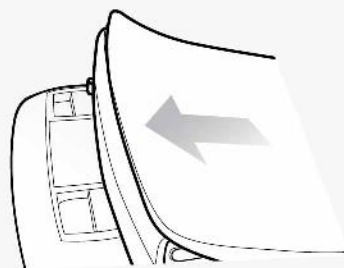

▶ Push it in until it sounds 'click'.
▶ When the product is not installed well, it may cause leakage.

7 After installing the filter onto the T-valve, connect the bidet-use hose to the bidet body.

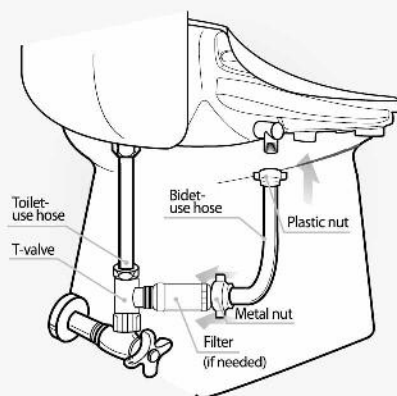

8 Insert the deodorizing cartridge into the bidet body. (DIB-J540 only)

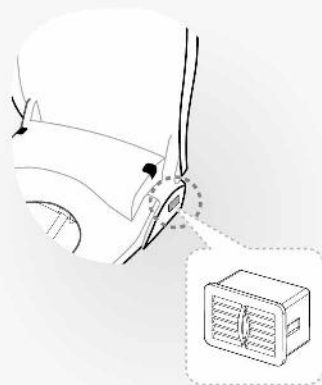

05. Trial Operation

Order of Trial Operation

1 Open the water feed valve by turning it anti-clockwise.

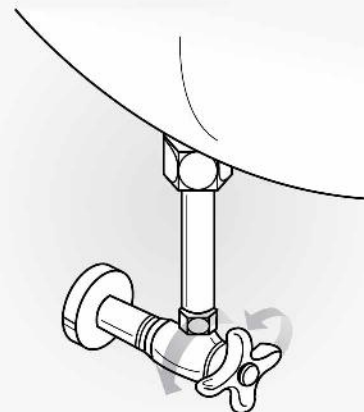

2 Be sure of no leakage around the hose connection.

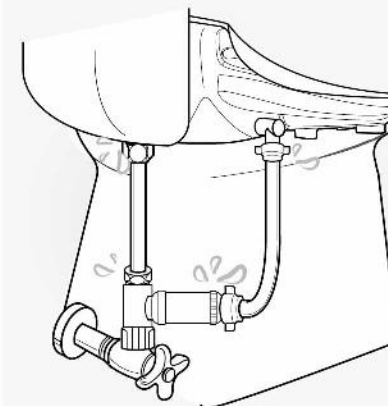

3 Be sure that nozzle comes out and retracts when powered on.

▶ Don't plug the power cord with wet hands.
Risk of electric shock.



4 When the unit is powered on, water tank will be filled immediately. The unit will beep until the water tank is fully filled up with water.

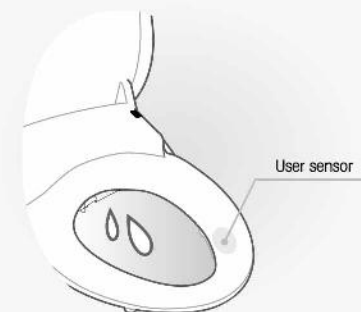

06. How to Use the Product

Basic Operation Method

1 Sit on the toilet seat.

- ▶ Be sure to sit on the user sensor of seat.
If the sensor is not occupied, functions will not work.

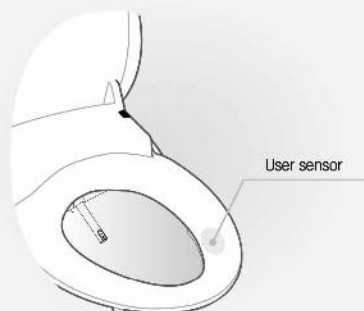

2 Press WASH, BIDET, Power wash buttons.

- ▶ Selected function can be used as desired.
- ▶ Sitz bath is possible in the mode of WASH and BIDET.
Press WASH or BIDET button again for Sitz bath.
e.g.) WASH + WASH = WASH SITZ BATH
BIDET + BIDET = BIDET SITZ BATH



5 MASSAGE Wash

- ▶ When Pressing the MASSAGE button, nozzle location will be changed back and forth to wash the wider range.

Massage

6 PULSE Wash

- ▶ When pressing PULSE button during the operation of WASH, BIDET and Power wash, water pressure will repeat +/- level for smooth pulsating wash.
(Massage is not available in Sitz bath mode)
- ▶ Press this button for 3 seconds to release the occupied seat sensor intentionally.

Pulse

3 Press the DRY button

- ▶ Hot air indicator lamp will light on.
- ▶ Dryer works for 3 minutes.
- ▶ It is recommended to wipe out the water on your bottom before operating the dry function for improving dry effect. (DIB-C520, C540 only)



4 Press the STOP button.

- ▶ Any operation will stop.
- ▶ Press STOP for 3 seconds to turn off the unit while not seated.



7 Water Pressure Control

- ▶ Pressing +/- button enables the control of water pressure.
- ▶ When any foreign material blocks the water filter, it may cause the low water pressure. Regularly check the water and screen filter.



8 Nozzle Position Control

- ▶ Nozzle position can be controlled by pressing </>.



06. How to Use the Product

Basic Operation Method

9 CHILD Function

- ▶ All settings are adjusted for child and after wash dry works automatically.
- ▶ Nozzle moves forward more than adult wash.
- ▶ Water pressure is weaker than adult wash.
- ▶ Seat temperature is set at lower than adult setting.

Child

10 Seat Temperature Control

- ▶ When pressing the SEAT TEMP. CONTROL button, the temperature of seat can be controlled within the range of room temperature, OFF-LOW-MID-HI

Seat Temp

11 WATER TEMP CONTROL

- ▶ When pressing the WATER TEMP. CONTROL button, the temperature of water can be controlled within the range of room temperature, OFF-LOW-MID-HI

Water Temp

12 Energy saving modes

- ▶ Automatic energy save mode
 - This mode will be activated by pressing the Energy Saving button until yellow LED lamp lights on.
 - Seat and water temperature will be kept at 32 .
- ▶ Power energy saving mode
 - This mode will be activated by pressing Energy Saving button until green LED lights on.
 - Seat and water temperature will be off when it is not occupied and raise the temperature back to the preset level when it is occupied.
- ▶ Cancel energy save mode
 - Press the Energy Saving button until LED is off to release the energy save modes.

13 Nozzle Cleaning

- ▶ While not sitting on the seat, and pressing the FR button three seconds, the nozzle will move forward at its maximum distance so that the user can clean it easily (It will return after 2 minutes)
- ▶ When pressing STOP button, the nozzle will return and operate self-cleaning operation.

Longer than
3 seconds



14 Deodorizing function (DIB-J540 only)

- ▶ When sitting on the seat, automatically the deodorizing function starts.
- ▶ After the usage of bidet, the deodorizing function will operate for one (1) minute.
- ▶ Automatic deodorizing function can be released by pressing STOP + Energy saving button while not seated.

15 Low temperature burn protection

- ▶ To reduce the chance of low temperature burns, the seat has a seat heater auto adjustment function which turns on low temperature (32°C, 90°F) when user sits on the seat for more than 15 minutes consecutively.



Consult your doctor before using Power Wash function in situations of anal disease/surgery.

Do not throw away

We are committed to protect the environment. Please help us by disposing of this product in a responsible way when it reaches the end of its service life, to prevent certain substances contained in electric and electronic products from harming public health or the environment. The symbol means that the products may not be thrown away with other household waste: at the end of its service life, it may be taken at no charge to you to the waste-collection centers provided for the purpose by the authorities in your country. It may be taken to the distributor from whom you purchase a new product that is equivalent to or that performs the same functions as this product. This later option may not be available in some countries.

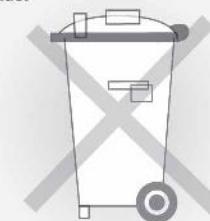

07. User Settings

● : Seat Switch 'Off' Status ○ : Seat Switch 'On' Status ◐ : Regardless of On/Off

No	Function	Seat Status	Switch Operation	Description	Initial Status
1	Operating Signal Cancel	●	Press MASSAGE for 3 sec.	Use when turning off the operating signal	Operating Signal is turned on
2	Turning off	●	Press STOP button for 3 sec.	Press one of STOP, WASH, BIDET and POWER WASH to turn on the unit.	
3	Manual nozzle cleaning	●	Press FR button for 3 sec.	To clean the nozzle manually.	
4	Seat occupied sensor release	●	Press PULSE button for 3 sec.	To release the seat sensor intentionally.	○
5	Automatic deodorizing ON/OFF	●	Press STOP button and press ENEGGY SAVING button.	To release automatic deodorizing fuction intentionally.	○
6	Initialization	●	Unplug the cord for 5 seconds and plug in.	Initializing all the functions to the initial status.	

- * The unit will work without activation of the occupied seat sensor if occupied seat sensor is released (turned off).
- * Some of functions, that must be set while not seated, are not available if occupied seat sensor is released (turned off).
- * If the occupied seat sensor is turned off, deodorizer works for the first 30 minutes after setting and it will not work anymore until occupied sensor is activated again.

dib

08. Maintenance & Cleaning

Cleaning of Water pipe filter

- 1 Close the water feed valve by turning it clockwise.
- 2 Disconnect the water supply hose. Take the screen filter out and clean it with soft brush. (e.g. toothbrush)
- 3 After cleaning, place it back. Then connect the water supply hose.
- 4 Open the water feed valve by turning it anti-clockwise.

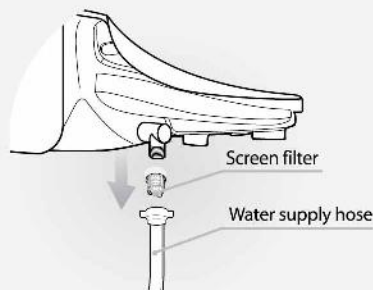

Cleaning of Nozzle

- 1 Press FR button for 3 seconds while not seated. The nozzle will move forward and stop for 2 minutes.
- 2 Clean the nozzle with a unused toothbrush, etc., and press the STOP button, then it will return to the original place for self cleaning.



Cleaning of Bidet Body

- 1 Exterior surface of bidet is made of plastic material, which may be damaged by scrubber, chemicals, etc.
- 2 Wipe the surface with a soft cloth wet and squeezed completely. Don't spray water directly onto the surface with the bath-use shower device.
- 3 Clean the body after removing the power plug from the outlet. Be sure no water splash to the power plug or outlet.
- 4 Don't touch the power outlet with wet hand. Risk of electric shock.



Drainage of Hot Water Tank

- 1 Remove the power plug from the outlet.
- 2 Close the water feed valve by turning it clockwise.
- 3 Press the release button on the side of main body. To prevent freezing, drain the water if unit is not used for extended period in winter.

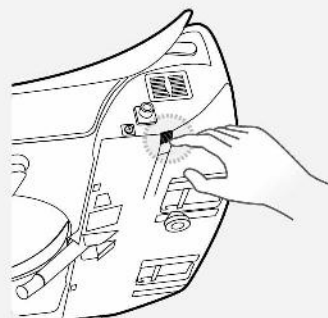

09. Before requesting repair

※ Please check the following points before requesting the repair of the product.

Signs to occur	Matters to be checked
Completely out of operation	<ul style="list-style-type: none"> • Check if the power plug is not connected. • Check the power failure.
Water does not spray out	<ul style="list-style-type: none"> • Check if the water supply is suspended. • Check if water feed valve is locked • Check if nozzle is blocked by foreign material • Check if connection hose is bent
Water pressure is low	<ul style="list-style-type: none"> • Check if water pipe filter is blocked by foreign material. • Check if the water pressure is set at too low level
Water is not warm enough	<ul style="list-style-type: none"> • Check if its temperature is set at 'Off' or 'Low'.
Seat is not warm enough	<ul style="list-style-type: none"> • Check if its temperature is set at 'Off' or 'Low'

Self-Diagnosis Table

※ When any abnormal phenomenon occurs, please refer to the following table, and inform the exact status at the time of requesting A/S service.

No	Self-Diagnosis Phenomenon	Way of Indication
1	Water temp sensor is disconnected or not inserted	LED of water temp. Yellow + Green blinking
2	Water temp sensor is short-circuited or over-heated	LED of water temp. Red + Yellow blinking
3	Seat temp sensor is disconnected or not inserted	LED of seat temp. Green blinking
4	Seat temp sensor is short-circuited or over-heated	LED of seat temp. Red blinking

10. Product Specifications

Item		DIB-J540	DIB-J520	DIB-J500
Rated Voltage		AC 220V ~ 240V, 50/60Hz		
Max. Consumption Power		1270W		
Power Cord Length		1.5m		
Water Feed Method		Direct connection		
Water Pressure		0.7~7.5kgf / cm ²		
Wash	Feeding Volume	Wash	0.6 ℓ/min	
		Bidet	0.6 ℓ/min	
		Power Wash	0.5 ℓ/min	
	Water Pressure Control	5 levels		
	Temp. Control	4 levels (Off, Low, Mid, Hi)		
	Heater Capa.	1200W		
	Safety Device	Thermal fuse, Thermal switch, Bi-metal		
Heated Seat	Temp. Control	4 levels (Off, Low, Mid, Hi)		
	Heater Capa.	55W		
	Safety Device	Thermal fuse		
Dry	Temp. Control	Room temp. ~50°C	-	
	Heater Capa.	250W	-	
	Safety Device	Thermal fuse, Bi-metal	-	
Deodorizer		Catalytic carbon filter	-	
Product Dimension	Elongated	18.5"(470) x 20.8"(528) x 7.5"(190)		
	Round	18.5"(470) x 20.8"(496) x 7.5"(190)		
Product Weight	Elongated	5kg [8kg]	4.9kg [7.9kg]	4.7kg [7.7kg]
	Round	4.9kg [7.9kg]	4.8kg [7.8kg]	4.6kg [7.6kg]

11. Comparison Chart

	Function	DIB-J540	DIB-J520	DIB-J500
Wash/Dry Function	Wash	●	●	●
	Bidet	●	●	●
	Power Wash	●	●	●
	Dry	●	●	
	Bubble Wash	●	●	●
Convenient / Comfort Function	Automatic Energy Saving	●	●	●
	Power Energy Saving	●	●	●
	Massage	●	●	●
	Pulse	●	●	●
	Advanced hybrid heating technology	●	●	●
	Warm Seat	●	●	●
	Soft Closing Lid & Seat	●	●	●
	Detachable Main Body	●	●	●
	Child	●	●	●
	Deodorizer	●		
	Stainless steel nozzle	●	●	●

Dimension diagrams

inch (mm)

